



E-mail: distributor@hyggeraquarium.com

Website: www.hyggeraquarium.com



HG076 USER MANUAL

hygger planted+24/7 aquarium
clip on & extendable LED light

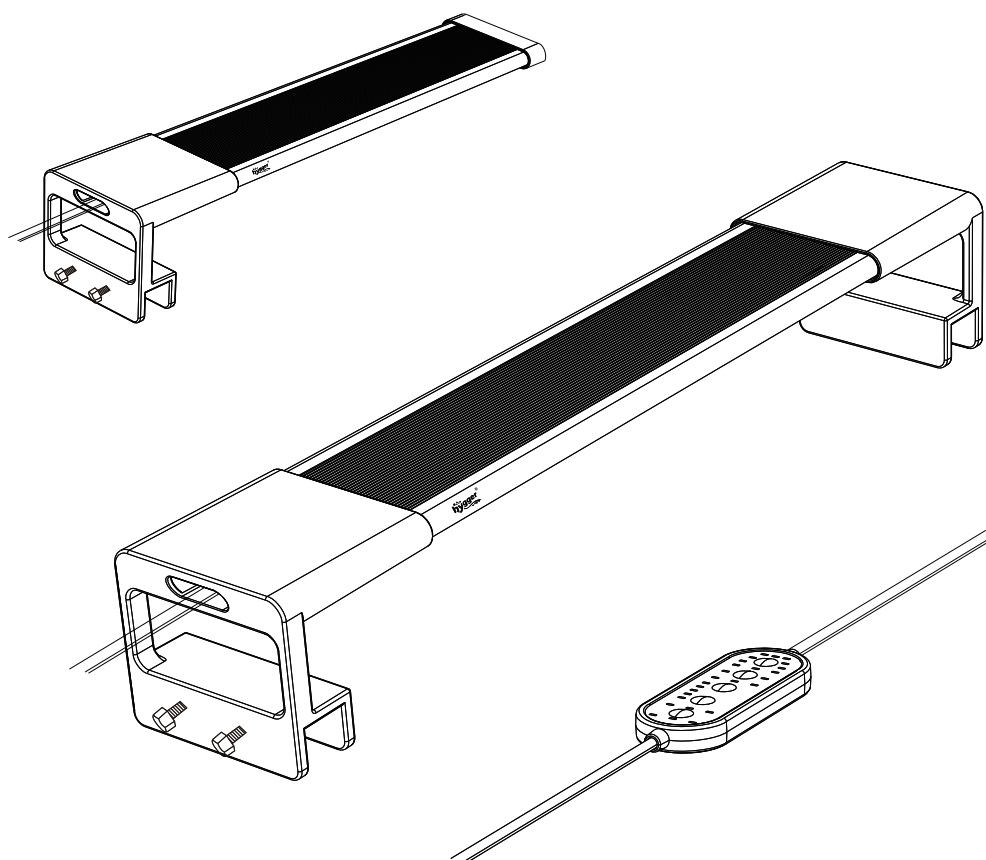

1. PRODUCT FEATURES

Super Bright: Premium 5050 and 2835 LEDs that provide bright illumination for your plants, fish, and enhance the aesthetic appeal of your tank.

Built-in Timer: Lighting time can be easily programmed to 6H, 8H, and 12H for daytime use and 3H, 5H, and 12H for nighttime use.

Adjustable Brightness: Lighting mode offers a choice of 10 colors (white- red- green- blue- orange- pink- cyan- yellow- light green-rose red) and 11-stages brightness levels(0-10%-20%-30%-40%-50%-60%-70%-80%-100%). Simply press the adjustment button to select the desired color and brightness, with a single blink indicating a specific value and no blink indicating a double value.

24/7 Lighting Mode: This aquarium light is designed to create a 24-hour gradual sunrise, sunset, and moonlighting effect, providing a natural rhythmic light cycle for your aquatic environment. It also features a one-key operation for easy setup, allowing you to choose between 6 AM, 7 AM, or 8 AM to initiate the light cycle.

Clip-on Bracket: The light comes with a clip-on bracket that is compatible with aquariums with a frameless width of 0.6 inches or flat plastic board. This versatile bracket ensures a secure and adjustable fit for different tank sizes.

Suitable for Plants and Freshwater: The full-spectrum bulbs used in this LED light are capable of producing different colors, making them suitable for both plants and freshwater setups.

2. PRODUCT PARAMETERS

MODEL	HG076-10W	HG076-12W	HG076-14W	HG076-20W
INPUT VOLTAGE	AC 100-240V	AC 100-240V	AC 100-240V	AC 100-240V
OUTPUT VOLTAGE	DC 20V	DC 20V	DC 20V	DC 20V
LED QUANTITY	30 PCS W: 16 R: 1 G: 1 B: 6 RGB: 6	60 PCS W: 32 R: 2 G: 2 B: 12 RGB: 12	90 PCS W: 46 R: 4 G: 4 B: 18 RGB: 18	120 PCS W: 60 R: 6 G: 6 B: 24 RGB: 24
LIGHT SIZE	7 INCH (18CM)	12 INCH (30CM)	18 INCH (45CM)	24 INCH (60CM)
APPLICATION	7-12 INCH (18~30CM)	12-18 INCH (30~45CM)	18-24 INCH (45~60CM)	24-28 INCH (60~72CM)
POWER CORD	4.9 ft+2.3 ft	4.9 ft+2.3 ft	4.9 ft+2.3 ft	4.9 ft+2.3 ft



MODEL	HG076-24W	HG076-36W	HG076-45W
INPUT VOLTAGE	AC 100-240V	AC 100-240V	AC 100-240V
OUTPUT VOLTAGE	DC 20V	DC 20V	DC 20V
LED QUANTITY	150 PCS W: 74 R: 8 G: 8 B: 30 RGB: 30	180 PCS W: 88 R: 10 G: 10 B: 36 RGB: 36	210 PCS W: 102 R: 12 G: 12 B: 42 RGB: 42
LIGHT SIZE	30 INCH (75CM)	36 INCH (90CM)	48 INCH (120CM)
APPLICATION	30-32 INCH (75~82CM)	35-40 INCH (90~102CM)	47-52 INCH (120~132CM)
POWER CORD	4.9 ft+2.3 ft	4.9 ft+2.3 ft	4.9 ft+2.3 ft

3.METHOD OF APPLICATION

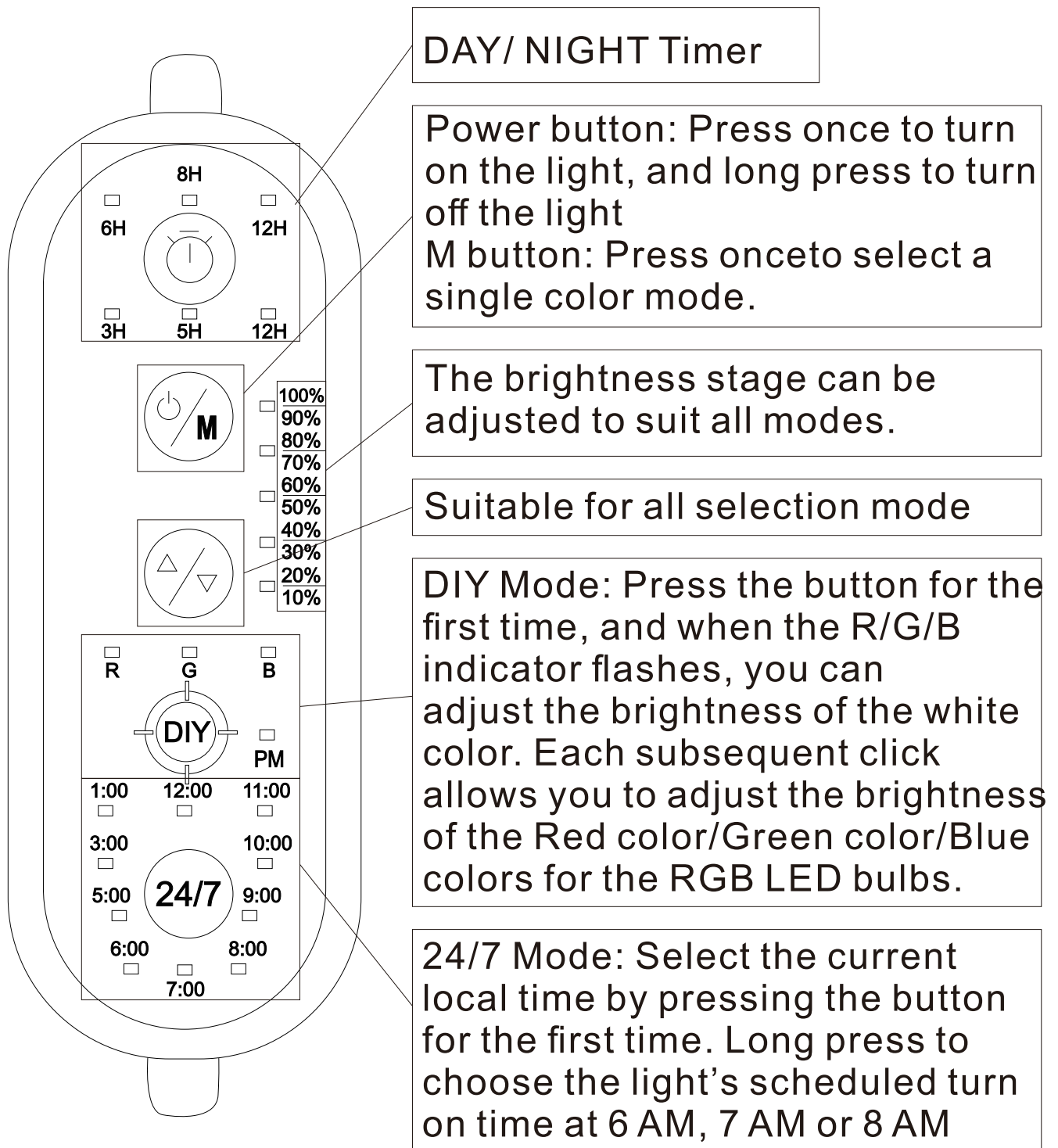



CONTROLLER DIAGRAM



INSTRUCTION TO SET THE LIGHT:

- ① Press  once to turn on the light, and long-press the same button to turn off the light.
- ② Press  to choose a single color from the available options: 100%white-red- green- blue- orange- pink- cyan- yellow-light green- rose red. Then, press  to adjust the brightness level. Each click increases the brightness by 10% (0-10%-20%-30%-40%-50%-60%-70%-80%-100%). Note that the button will blink for a single value and not blink for a double value when adjusting the brightness.
- ③ **DIY “DAY” and “NIGHT” TIMING:**



DAY TIMING SETTING:



- Long press , until the 6H/8H/12H indicator light turns on in white. Then press  and observe the indicator, which will flash to indicate the selected number of hours.
- Long press “” and all the R/G/B indicators will flash, indicating that you can set the brightness of the white color (excluding RGB LED bulbs). Please pay attention to that the white color will turn off after you press 100%.
- Press , and you will see the R/ G/ B indicators flashing separately. Press  to adjust the brightness of RED/GREEN /BLUE colors.

Note: This function only can adjust the brightness of RGB LED bulbs for RED/GREEN /BLUE colors.





Tips 1: Press , and the R indicator will flash. Then press  to choose brightness level (0~100%).

100%
90%
80%
70%
60%
50%
40%
30%
20%
10%

Tips 2: Press , and the G indicator will flash. Then press  to choose brightness level (0~100%).

Tips 3: Press , and the B indicator will flash. Then press  to choose brightness level (0~100%).

④ NIGHT TIMING SETTING, follow the same steps as DAY TIMING setting:

- Press  ----> 3H/5H/12H indicator will flash ---> press  indicator flash ---> press  to confirm the night timer selection and proceed to the color brightness setting for White/Red/Green/Blue --- press  confirm and save the DAY/ NIGHT settings.

- Press  to review the DIY setting.

⑤ 24/7 PROGRAM SETTING:

24/7 lighting mode simulates a natural light cycle for your fish tank, with a gradual transition from dim orange light at dawn to bright full spectrum light during the day, and blue light at night. Once set, the light will automatically turn on and off at the same time every day. In this mode, the light

color and intensity are fixed and cannot be changed. The PM indicator light on the top indicates the current time range.

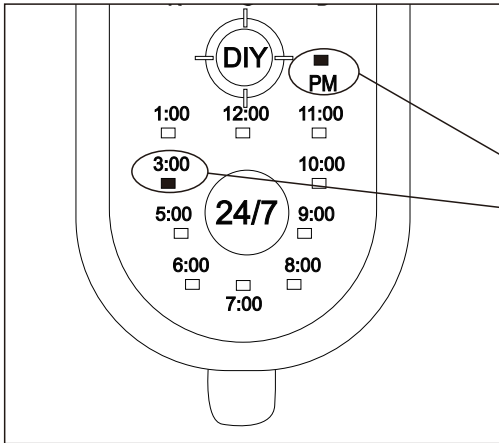

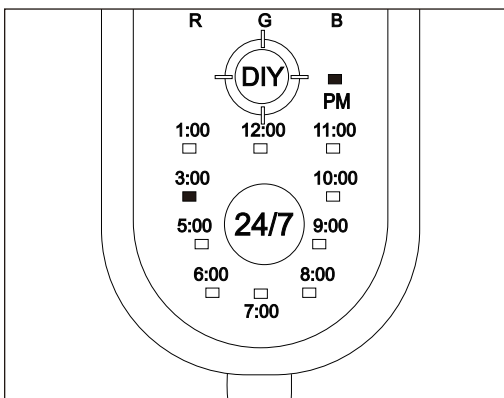

The PM indicator light and digital lights are synchronized to indicate the PM time period, while the PM light is off for the AM time period.

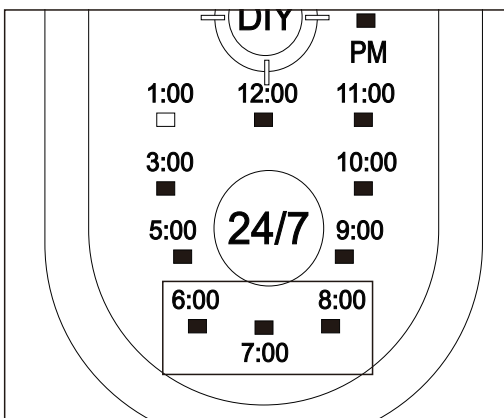

* Press the 24/7 button and then press choose a real local time. The indicator light will turn on to indicate the selection.



* Long press the 24/7 button and press  to choose the desired light on time (6 AM/7 AM/8 AM).

– Press  once and press  to choose the nearest local time. The time indicator light will turn on to indicate the programmed setting. This setting will repeat every day.

There are 10 available time options (1:00/3:00/5:00/6:00/7:00/8:00/9:00/10:00/11:00/12:00) for real time alternatives.

– Long press  to choose the light at the time of 6 AM, 7 AM, or 8 AM if desired.

– Press  confirm to save the setting and return to the whitemode.

24/7 Program default setting: 6AM~10:30PM

e .g:

A) If you select the 24/7 mode at 6 AM local time, the light will turn off at 10:30 PM, and automatically turn on the following day at 6 AM.

B) If you select the 24/7 mode at 5:00 PM, but the real local time is 4:45 PM, the light will turn off at 10:15 PM and the following day it will turn on at 5:45 AM.

4. ATTENTION

✓ Please read the manual carefully before using it and follow all instructions.

✓ Please keep the switch away from water, the switch is not waterproof.

✓ Please keep the light away from flammable items.

✓ Please unplug the power and contact the seller if the light is not working properly, ****OPENING WILL VOID WARRANTY****

✓ Please unplug the power before maintenance.

✓ Please remember that the temperature range for the light is 23~113°F.

5. PACKAGE INCLUDES

1× LED light

1× AC/DC power adaptor

2× Plastic brackets(1PC plastic bracket for 10W/12W/14W)

1× User manual

6. WARNING: To avoid possible electrical shock, do not immerse the switch in water. If the switch falls into the water, or otherwise becomes wet, do not touch it until you have unplugged it. Basic safety precautions should be observed including the following:

1. Read and follow this user manual strictly.

2. **DANGER-**To avoid possible electric shock, special care should be taken. For each of the following situations, do not attempt to repair yourself; return the light to an authorized service facility for service or discard the light.

A. Carefully examine the light after installation. It should not be plugged in if there is water on parts not intended to be wet.

B. Do not operate the light if it has a damaged cord or plug, if it is malfunctioning, or if it is dropped or damaged in any manner. The power cord of this light cannot be replaced, if the cord is damaged, the light should be discarded.

C. To avoid the possibility of the light plug getting wet, position aquarium stand and tank to one side of a wall mounted receptacle to prevent water from dripping onto the receptacle or plug. A “drip loop”, shown in the figure below, should be arranged by the user for each cord connecting the light to the receptacle. The “drip loop” is the part of the cord below the level of the receptacle, or the connector. If an extension cord is used, to prevent water traveling along the cord and

coming in contact with the receptacle. If the plug or receptacle does get wet, DO NOT unplug the cord. Disconnect the fuse to the circuit breaker that supplies power to the light. Then unplug and examine for the presence of water in the receptacle.

POWER CORD

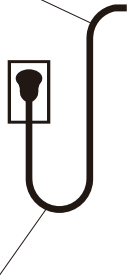

DRIP LOOP

3. Close supervision is necessary when the light is used near children.
4. To avoid injury, do not touch moving or hot parts.
5. Make sure the light is securely installed before operating it.
6. Read and observe all the important notices on the light.
7. If an extension cord is necessary, a cord with a proper rating should be used. A cord rated for less amperes or watts than the appliance rating may overheat. Care should be taken to arrange the cord so that it will not be tripped over or pulled.
8. The light is intended FOR HOUSEHOLD USE ONLY.
9. SAVE THIS USER MANUAL.

7. ONE YEAR LIMITED WARRANTY

This product **MUST** be purchased from an authorized hygger reseller. Visit our website for a list of unauthorized resellers. hygger warrants this product against defects in materials and workmanship for **ONE(1) YEAR** from the date of the original retail purchase and is none-transferable.

Warranty on all products, including aquariums. But it is limited to the replacement of the products and does not cover fish loss, personal injury, property loss or direct, incidental or consequential damage caused by using this product.

Note: hygger One-year Limited Warranty does not cover damage caused by the followings: improper installation, saltwater corrosion, electrical surges or modifications. Additionally, products that have been refunded are also not covered under the warranty.

If you discover a defect, please contact hygger, who will, at it's option, repair or replace the product at no charge, provided that you return it during the warranty period. A copy of the bill of sale is required as a proof of the original purchase date in the event of the product needing repairs within the warranty period. Hygger does not warrant any products that are not hygger's.

This warranty does not apply if the product has been damaged by accident, abuse, misuse or misapplication, or modified without the written permission of hygger.

8. DISPOSAL

Do not dispose this product as unsorted municipal waste. This product must not be disposed together with the domestic waste it must be disposed of at an authorized place for recycling of electrical and electronic appliances. By collecting and recycling waste, you help save natural resources, and make sure the product is disposed in an environmental friendly way.



9. CONTACT INFORMATION

Distributed by: Hygger Aquarium, Inc.
Chino, CA 91710

E-mail: distributor@hyggeraquarium.com

Website: www.hyggeraquarium.com

Trademarks of Shenzhen Mago Trading Co., Ltd
Bantian Group Business Center, Longgang,
Shenzhen City, China
All Rights Reserved

Made in China



MADE IN CHINA